

Plasma parameters investigation in the near cathode zone of the SPT discharge

IEPC-2005-61

Presented at the 29th International Electric Propulsion Conference, Princeton University,
October 31 – November 4, 2005

A.A.Pereslavitsev[†],
S.A.Khartov^{*}

Moscow Aviation Institute (State University of Aerospace Technologies) MAI
4, Volokolamskoe sh., Moscow, 125971, Russia

Abstract: Up to now it is not known completely how electrons move from a cathode – compensator (CC) into the SPT channel. There is no single meaning about electron parameters in near cathode area of the discharge, its function of distribution over energy (EEDF). But it is clear that the processes taking place in the area between cathode and exit of the accelerating channel influence significantly onto SPT operation. The results of the previous experiments show that EEDF is closed to Druyvesteyn distribution with ill-defined additional group of electrons with mean energy ~ 4 eV, which is closed to a group of intermediate electrons in the SPT channel. But it is necessary to carry out an additional experimental investigation concerning electron dynamic in the area between cathode – compensator and SPT exit cross section in order to confirm a hypothesis about EEDF formation in the SPT channel. The experiments were done using SPT-70 prototype with a laboratory hollow diaphragm - type cathode. Special facility and processing procedure permitting to obtain proper performances were developed. The first experimental results are presented in the paper.

Nomenclature

A	= area of probe receiving surface (m ²)
C	= heat capacity coefficient (J/kg·K)
D	= Debye screen radius
E _c	= maximum energy of the electrons (V)
φ _a	= electronic work function of probe material (V)
I	= probe current (A),
x	= current length of the probe (m),
λ	= heat conductivity (W/m·K), ρ- probe material density (kg/m ³),
λ _m	= the smallest average length of particle free motion between collisions with other charged or neutral particles
ρ	= probe material density (kg/m ³)

[†]Post-graduate student, Electric Propulsion and Space Power Plants Department, e-mail: k208@mai.ru

^{*} Leading scientist, Electric Propulsion and Space Power Plants Department, e-mail: k208@mai.ru

I. Introduction

Theoretical analysis of SPT plasma parameters^{1,2,3} shows possible⁴ mechanism of electron energy distribution function (EEDF) formation in the SPT channel. Its view is determined by initial distribution of electrons coming to the channel from a cathode – compensator (CC). In this paper it is shown that distribution function form (Fig.1), which has three groups of electrons¹ can be explained by the existence of only two groups of electrons. First group – are the electrons formed as a result of propellant ionization; their EEDF is Maxwellian. Second – is magnetized beam of electrons coming to the channel from CC; their EEDF is also Maxwellian but displaced in such a way that mean energy corresponds to beam average energy and the temperature determines electron energy range in the beam (Fig.2).

In Fig.3 it is shown how beam EEDF changes with variation of energy drift share. So, EEDF view in the SPT channel depends on the ratio between first group of electron and energy drift share in beam total energy. As a result, formally, distribution function can have up to four maximums while in reality there are only two groups of electrons (Fig.4).

The results of the experiments^{6,7} in the near-cathode area show that EEDF in this area is closed to Druyvesteyn distribution with ill-defined additional group of electrons with mean energy ~ 4 eV, which is closed to a group of intermediate electrons in the SPT channel¹. The same results were obtained by other researchers⁵. The existence of such group of electrons in the near-cathode area can confirm a hypothesis⁴ about EEDF formation in the SPT channel. But it is necessary to carry out an additional experimental investigation concerning electron dynamic in the area between cathode – compensator and SPT exit cross section. Such group of electrons can be formed near cathode – compensator after their coming through potential drop ~ 30 V between CC and SPT exit cross section. Just under this value of beam energy the view of theoretical EEDF and experimental one has good agreement⁴.

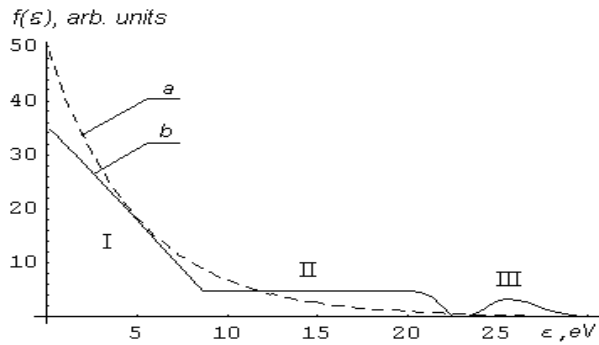

Figure 1. Maxwellian function (a) and EEDF in the SPT channel (b).

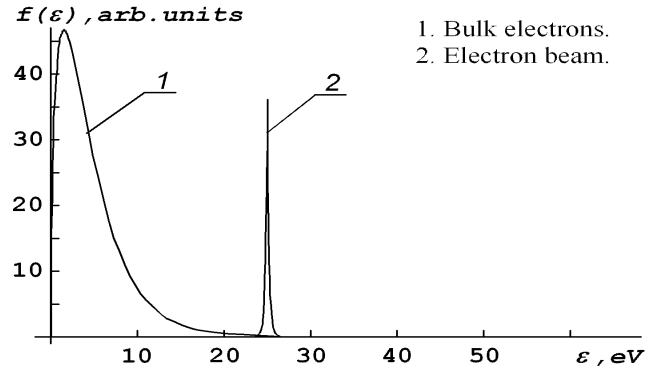

Figure 2. Two groups of electrons

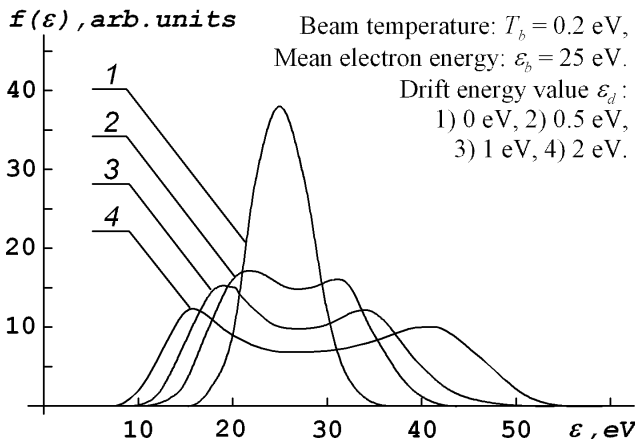

Figure 3. EEDF of magnetized beam for different drift energy values

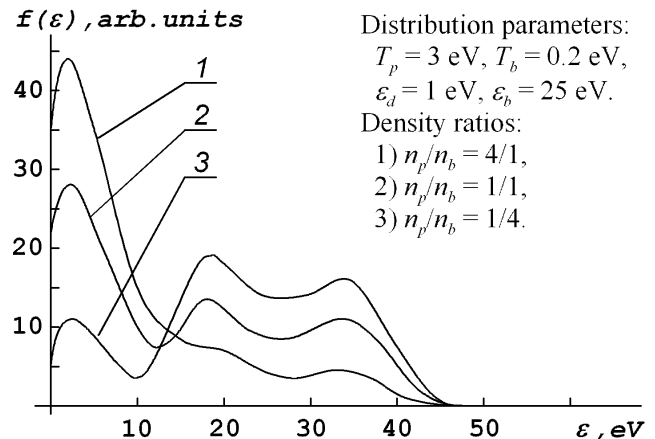

Figure 4. EEDF versus different n_p/n_b values

II. Experimental facility and test description

The experiments were carried out at MAI test facility with vacuum chamber volume 3 m^3 (0.9 m in diameter)⁸. Dynamic vacuum in the chamber $(3 \div 7) \cdot 10^{-5}$ Torr was secured with the help of two oil diffusion pumps with capacity 20000 l/min.

For the experiments it was chosen SPT-70 laboratory prototype (nominal power operating point - 700 W). The laboratory hollow diaphragm - type cathode was used. Its scheme with flat emitter made of lanthanum hexaboride with indirect heating is in Fig.5. The peculiarity of the heating scheme for this cathode is: it is necessary to heat the emitter permanently during thruster oration. For emission control (heater current is controlled) it is used the electrode-ignitor's to ground potential. The experiments were carried out at the following thruster operation points: mass flow 2.2 mg/s, voltage 200, 300, 400, 550 and 600 V. The cylindrical Langmuir probes were used for plasma parameters registration. Its position in the near cathode region is shown in Fig.6.

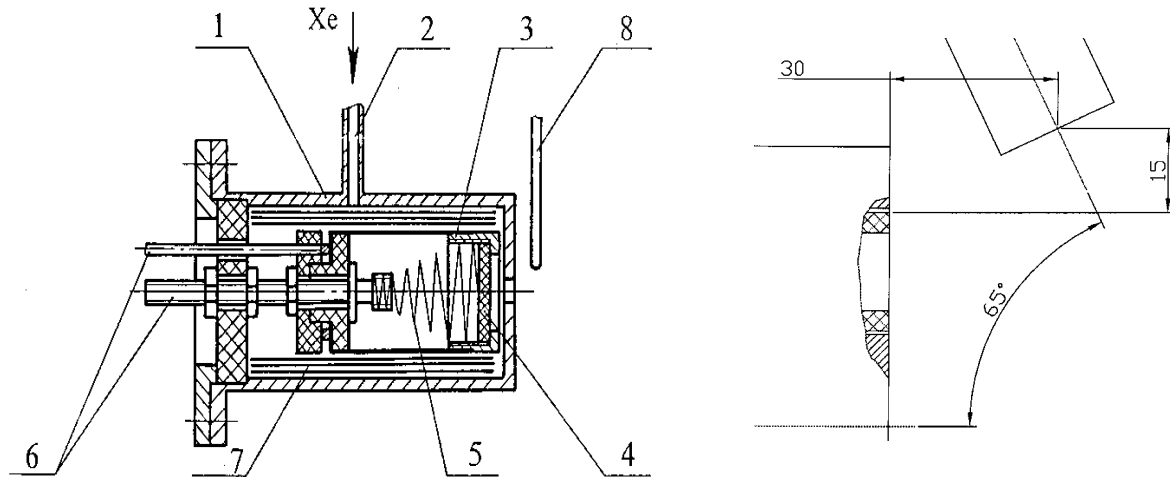

Figure 5. Cathode structure scheme and position 1 - body; 2 - gas pipeline; 3 - emitter holder; 4 - emitter; 5 - heater; 6 - electric inputs; 7 - thermal screens; 8 - ignition electrode.

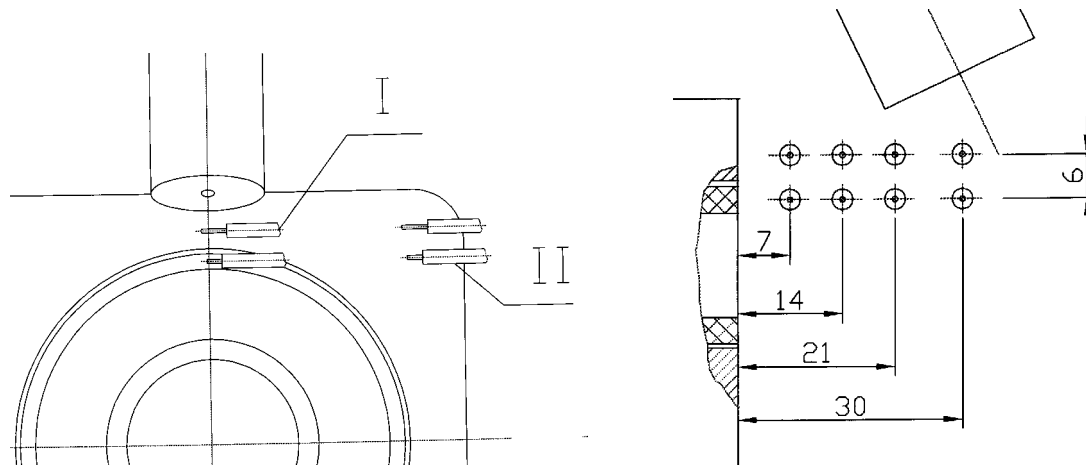

Figure 6. Probe positioning

Langmuir probe usage is justified most completely and correct (theoretically and experimentally) for rare isotropic plasma, which is in weak magnetic fields. In the case of magnetized plasma, typical for SPT, not only the

probe experiments become extremely complicated, but also the results of the experiments themselves cannot be applied directly to the performances determining experimentally. It is possible to estimate plasma parameters using probe performances with the help of Langmuir theory only in the case of Maxwell distribution of charged particle velocities. Under conditions of SPT near-cathode plasma electron energetic distribution consists of so-called “electron groups”, i.e. of some amount of independent distributions caused by different plasma processes. If we know preliminary the form of these distributions approximately, it is possible to divide electron current to several parts corresponding to different groups with the help of graphical procedure^{14, 16 – 19}. In all other cases it is recommended to use Druyvesteyn M.J^{9, 10} procedure, in which the second derivative of the electron current is measured.

For the typical parameters of near-cathode plasma²⁰, Larmor radius is $\sim 0,5 \dots 2$ mm. So, probe diameter should be less than 2 mm. It is possible to say that probe diameter should be $0.1 < d_p \ll 2$ mm.

For plasma parameters examination in the near-cathode area in SPT in the majority of cases the cylindrical Langmuir probes^{5, 20, 21} were used. The ratio between probe operation part and its diameter is about 10, as far as in this case it is possible does not take into account its end plate area and to decrease isolator influence. In the majority of publications, an electronic part of CVC was processed. It is due to the following reasons: first – electron current to the probe is much higher than ion one; second – from the electronic branch of CVC one can obtain information about non-Maxwell group of electrons presenting in plasma.

The electron current value receiving by the probe should not influence on to examined plasma parameters and thus to the thruster parameters. Knowing the rang of possible probe sizes²⁰ and using the number 10 as a ratio between the length of operating part of the probe and its diameter, one can determine possible electron currents onto assuming cylindrical Langmuir probe. Current density on the probe is $3 \dots 5 \cdot 10^5$ A/m².

If probe wire is made of tungsten and its diameter is, for example, 0.8 mm and the operating part of the probe is 3 mm we obtain the electron current limited value – about 180...500 mA. There is a danger that the probe can be heated that causes thermo-emission from its surface and probes operation part can be melted.

As an example of thermo-emission influence, it is possible to estimate the time during which the operational part of the probe is heated up to the temperature under which the emission from the probe become noticeable.

For the estimations, it is possible to examine the classical task about thermo-conductivity of semi-limited body²¹ with temperature T_0 . The limited surface is heated by constant heat flow $q_c = \text{const}$. The temperature is changing in one direction. The solution of this task is:

$$T(x, \tau) - T_0 = \frac{q_c}{\lambda} \int_x^{\infty} \text{erfc} \frac{x}{2\sqrt{a\tau}} dx = \frac{2q_c}{\lambda} \sqrt{a\tau} \text{ierfc} \frac{x}{2\sqrt{a\tau}}, \quad (1)$$

where

$$\text{ierfc} u = \int_u^{\infty} \text{erfc} W dW = \frac{1}{\sqrt{\pi}} e^{-u^2} - u \text{erfc} u,$$

$$\text{erfc} u = 1 - \text{erf} u$$

$$q_c = (2E_e + \varphi_a) \frac{I}{A};$$

$$a = \frac{\lambda}{\rho C}.$$

Here x – current length of the probe (m), E_e – maximum energy of the electrons (V), φ_a – electronic work function of probe material (V), I – probe current (A), A – area of probe receiving surface (m²), λ – heat conductivity (W/m·K), ρ – probe material density (kg/m³), C – heat capacity coefficient (J/kg·K).

For the chosen probe material – tungsten – rhenium alloy we have the following reference parameters: $\lambda = 50 \dots 75$ W/m·K, $\rho = 20000$ kg/m³, $C = 132 \dots 158$ J/kg·K, $\varphi_a = 4.54$ eV.

Melting temperature of the tungsten – rhenium wire is $T_{m, W-Re} \sim 3500$ K; recommending temperature of probe isolator operation is $T_{\text{operation}} = 1623$ K. The last temperature value can be assumed as a limitation of probe usage in plasma. Giving needed x and using tables for ierfc – functions, one can find τ . Thus, for $x = 10^{-5}$ m – $\tau = 14.35$ s. This time value is oversized estimation, as far as the obtained value for electron current to the probe is realized only in the limited “saturation” area of CVC. But it is possible to use this value as a boundary one.

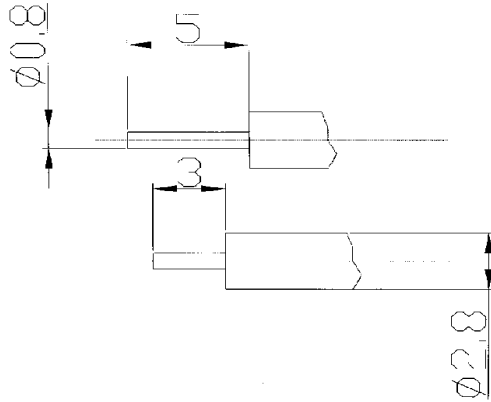

So, for plasma parameters measurements it is assumed to use the cylindrical Lengmuir probe made of tungsten wire 0.8 mm, probe length considering ceramic ~100 mm (Fig. 7). It is possible to assume that this probe satisfies to the condition of semi-limited body and the task examined before is true for it.

Figure 7

Processing procedure in the case of non-Maxwell electrons presence

Usually for CVC procession the well known graphical method is used^{14,18}.

If this method is used for experimental CVC procession, it is assumed that electron distribution consists of two parts: 1) “initial” distribution of mono-energetic electrons with high energy and stochastically directed velocities; 2) Maxwellian distribution of the electrons with low average energy.

Lets examine a group of mono-energetic electrons n_p with energy E_p . Lets assume that their velocities are distributed stochastically. So, the probe current can be written as:

$$i_p = (Aen_p/4)(2eU_p/m_e)^{1/2} [1 - (U/U_p)], \quad (2)$$

where U_p - energy E_p represented in eV. In this case CVC has a linear form. Under plasma potential when $U=0$,

$$i_{np} = (Aen_p/4)(2eU_p/m_e)^{1/2} \quad (3)$$

CVC built in linear scale are processed graphically. For this purpose in the linear part of the CVC a tangent to the curve is built (Fig.8). Using the point where the tangent intersects an abscissa axis (probe potential axis) one can determine the value of energy for mono-energetic group. Knowing U_p it is possible to determine n_p with the help of Eq.(3).

Then subtracting the tangent function from the initial CVC, it is assumed to obtain a performance for Maxwell group of electrons, and from it – plasma potential. Then all other parameters are determined. Strickfaden W.B., Geiler K.L.¹⁴ give the following substantiation for the assumption. The initial electrons are those electrons, which coming out a cathode, accelerating in near-cathode drop and have no collisions. Thruster magnetic field creates stochastic distribution of velocity. Non-elastic collisions of the initial electrons with neutral atoms cause electrons with Maxwellian distribution over energies. On the other hand such approximation has a disadvantage: elastic collisions electron – electron and electron – atom should cause dispersion in initial electron energies.

It is also possible to determine plasma potential with the help of the first and the second current derivatives with respect to potential^{15, 19}. The matter of fact is that often CVC are expressed not very clearly. The drawing of the first current derivative with respect to potential in the point of plasma potential has more sharp inclination than the current itself. In this case plasma potential point is a point in which the derivative has maximum value. If one uses the drawing of the second current derivative with respect to potential, the point of plasma potential is a point in which the derivative changes its sign.

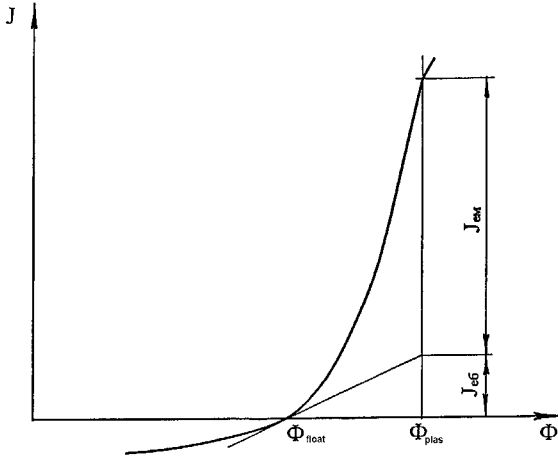

Figure 8. Probe curve procession

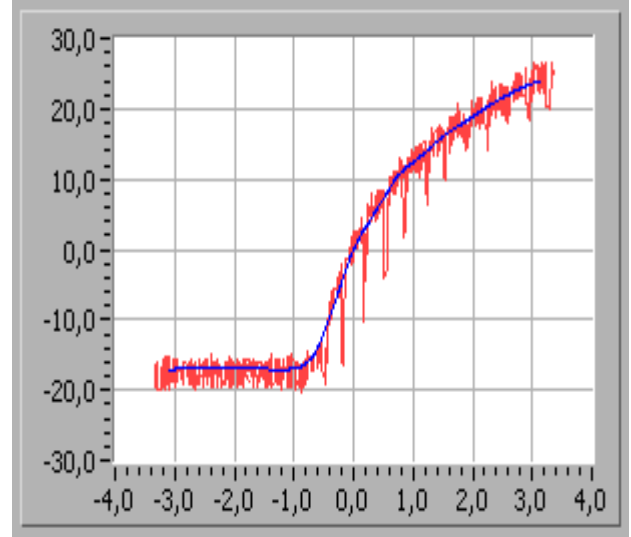

Figure 9. Typical probe CVC view (red color – real signal, blue – after preliminary procession)

For probe measurements the special designed saw signal generator was used. The generator has the following parameters:

- scanning potential – from –50 up to +50V;
- scanning potential period - 200±20 ms;
- probe current from –200 mA up to +100mA;

III. Data processing

Typical probe CVC view is represented in Fig. 9. From the figure one can see that the initial signal should be preliminary processed due to great noises. Sequence of operations is the following:

Preliminary filtration of coming out points

Preliminary filtration is needed in order to filtrate single coming out points and to reduce oscillations (peaks and splashes) with high amplitude (relatively ground noise). In order to show up the coming out points, it is used the smoothed values and the mean-square deviation values determined separately for every channel of the initial set with the help of filtration procedure.

In 2D case it is possible to use two approaches permitting to show up the coming out points. In the first case the channels are processed separately and coming out points are determined separately for every channel. A criteria permitting to show up the coming out points is the following:

$$|x_i - \bar{x}_i| > C_x \sigma_{x,i}, \quad (4)$$

where x_i – point coordinates of the initial set, \bar{x}_i – smoothed (averaged) coordinate values, $\sigma_{x,i}$ – corresponding mean-square deviation values, C_x – preliminary set coefficient, which is usually hits in the limits 0.5-1.0. Then if it is happened that any point is the coming out one, it is deleted from the set. I.e. the point (x_i, y_i) of the initial set is declared as a coming out, if the following relationship Ω_i is true:

$$\Omega_i = [|x_i - \bar{x}_i| > C_x \sigma_{x,i}] \vee [|y_i - \bar{y}_i| > C_y \sigma_{y,i}]. \quad (5)$$

In the second case the point (x_i, y_i) of the initial set is declared as a coming out, if it is out of the ellipse with the semi-axis $(C_x \sigma_{x,i}, C_y \sigma_{y,i})$ and with center in the point (\bar{x}_i, \bar{y}_i) , i.e. if the following relationship Ω_i is true:

$$\Omega_i = \left(\frac{x_i - \bar{x}_i}{C_x \sigma_{x,i}} \right)^2 + \left(\frac{y_i - \bar{y}_i}{C_y \sigma_{y,i}} \right)^2 > 1. \quad (6)$$

Filtration and smoothing

The main background noise is filtered. For this purpose the following procedures are applied step-by-step: filtration according to sliding mean method, set point selection procedure (in ascending order), additional filtration of coming out points (optionally), additional filtration according to sliding mean method.

Filtration according to sliding (moving) mean method

The idea of the procedure: to the initial set values $\{x_i\}$ it is corresponded the values of the resulted set $\{\bar{x}_i\}$ equal to arithmetical mean value in point i and $2R$ values in the neighbor points, in R points at every side from the point i :

$$\bar{x}_i = \frac{1}{2R+1} \sum_{j=i-R}^{i+R} x_j \quad , \quad (7)$$

where $i=0 \dots n-1$, n – set length, R – semi-width of window of averaging. When the value \bar{x}_i is calculated at set edges, the semi-width of window of averaging is changing, i.e. R value depends on point i number:

$$R = \begin{cases} i, & 0 \leq i < r \\ r, & r \leq i < n-r \\ n-i-r, & n-r \leq i < n \end{cases} \quad . \quad (8)$$

where r – nominal (maximum) semi-width of window of averaging .

Error calculation

If inaccuracy of measurements Δx_i of the initial set are known, the inaccuracy of the resulting set $\Delta \bar{x}_i$ can be determined as an inaccuracy of indirect measurements:

$$\Delta x_i = \frac{1}{2R+1} \sqrt{\sum_{j=i-R}^{i+R} (\Delta x_j)^2} \quad . \quad (9)$$

If inaccuracy of measurements for all points of the set is the same and equal to Δx , the inaccuracy of the resulted set points can be determined simply:

$$\Delta \bar{x}_i = \Delta x / \sqrt{2R+1} \quad . \quad (10)$$

If we do not know the inaccuracy of measurements of the initial set, it can be determined as the inaccuracy of the direct measurements:

$$\Delta \bar{x}_i = t_{P,2R} \frac{1}{\sqrt{2R(2R+1)}} \sqrt{\sum_{j=i-R}^{j+R} (x_j - \bar{x}_j)^2} \quad , \quad (11)$$

where $t_{P,2R}$ – Student's distribution quantile, corresponding to a number of degree of freedom $2R$ under confidence probability P . Besides, for inaccuracy estimation it is possible to use a mean square error value σ_i and dispersion σ_i^2

$$\sigma_i^2 = \frac{1}{2R} \sum_{j=i-R}^{i+R} (x_j - \bar{x}_j)^2 \quad . \quad (12)$$

In practice in order to accelerate the calculation procedure, if a set value $\{\bar{x}_i\}$ is calculated, it is possible to use the following relationship instead of (7):

$$\bar{x}_i = \frac{1}{2R+1} X_i \quad , \quad (13)$$

where $X_i = \sum_{j=i-R}^{i+R} x_j$ is calculated recurrently:

$$X_i = X_{i-1} - x_{i-R-1} + x_{i+R} \quad . \quad (14)$$

By the same way, if one calculates inaccuracies, the following relationship can be used instead of (6):

$$\Delta \bar{x}_i = \frac{1}{2R+1} \sqrt{D_i^2} \quad , \quad (15)$$

where $D_i^2 = \sum_{j=i-R}^{i+R} (\Delta x_j)^2$ is calculated recurrently:

$$D_i^2 = D_{i-1}^2 - (\Delta x_{i-R-1})^2 + (\Delta x_{i+R})^2 . \quad (16)$$

and instead of (11) and (12) – the relationships

$$\Delta \bar{x}_i = t_{P,2R} \frac{1}{\sqrt{2R+1}} \sqrt{\frac{S_i^2}{2R+1} - \bar{x}_i^2} , \quad (17)$$

$$\sigma_i^2 = \frac{1}{2R+1} S_j^2 - \bar{x}_j^2 , \quad (18)$$

where $S_i^2 = \sum_{j=i-R}^{i+R} x_j^2$ is calculated recurrently:

$$S_i^2 = S_{i-1}^2 - x_{i-R-1}^2 + x_{i+R}^2 . \quad (19)$$

The values of the initial set Eqs.(15), (16) and Eq.(10) considering semi-width of window of averaging R as a dependence on point number i Eq.(8), relationships for mean values calculation Eqs.(13), (14) and inaccuracies under known errors of the initial set Eqs.(15), (16) and Eq.(10) are represented in table 1.

The relationships for inaccuracies and dispersions Eqs.(17), (18) and Eq.(19) considering Eq.(8) are represented in table 2.

Filtration according to sliding (moving) polynomial

The idea of the procedure: to the values of y_i coordinate of the initial set $\{(x_i, y_i)\}$ it is corresponded the values \bar{y}_i of the resulting set $\{(x_i, \bar{y}_i)\}$ equal to polynomial $p_m(x)$ values under $x = x_i$.

$$\bar{x}_i = \frac{1}{2R+1} \sum_{j=i-R}^{i+R} x_j , \quad (20)$$

where $i=0 \dots n-1$, n – set length, R – semi-width of window of averaging. When the value \bar{x}_i is calculated at set edges, the semi-width of window of averaging is changing, i.e. R value depends on point i number:

$$R = \begin{cases} i, & 0 \leq i < r \\ r, & r \leq i < n-r \\ n-i-1, & n-r \leq i < n \end{cases} . \quad (21)$$

where r – nominal (maximum) semi-width of window of averaging.

If inaccuracy of measurements Δx_i of the initial set are known, the inaccuracy of the resulting set $\Delta \bar{x}_i$ can be determined as an inaccuracy of indirect measurements.

IV. Results

System finishing was done with the help of Lengmuir probe and an energy – analyzer placed at the distance 500 mm from the thruster exit cross section. Typical curves and the results of their processing are represented in Fig.10. From the given drawings one can see that the developed facilities and the software permit to obtain reliable information about plasma parameters and can be applied for the researches. In the Fig. 11 ...17 the results of the first experiments are presented. There one can see that it exists some correlation earlier published results⁵. Some existing artifacts can be explained by the inaccuracy of the processing procedure. The analysis shows that mainly it occur due to the chosen filtration method. In general the first experiments give as assurance that if one took in to account that obtained EEDF is the result of composition of two separate EEDF, belonging to different electron gropes, the artifacts will disappeared. In the nearest future the authors plan to continue the experiments with modified processing procedure.

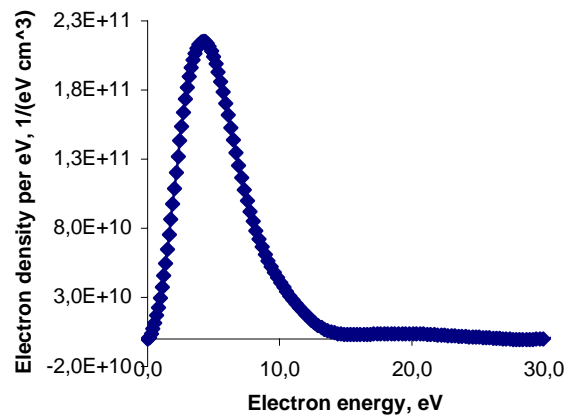
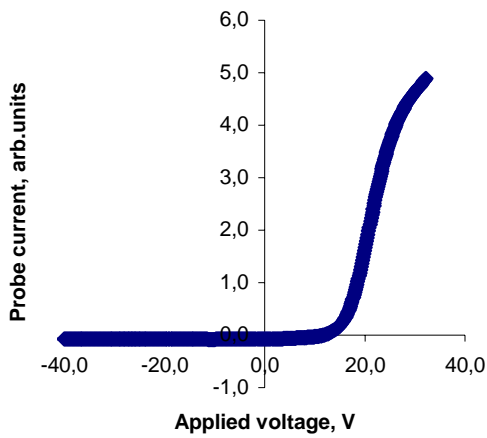

Figure10 Probe measurements in the plume (500 mm)

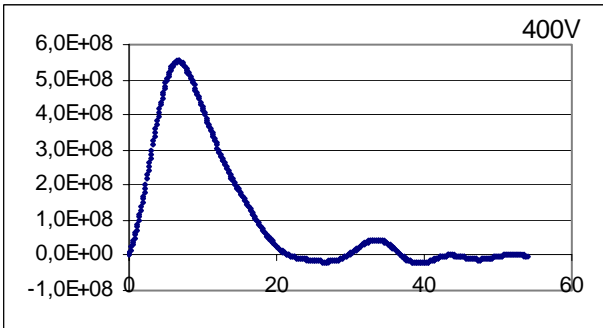
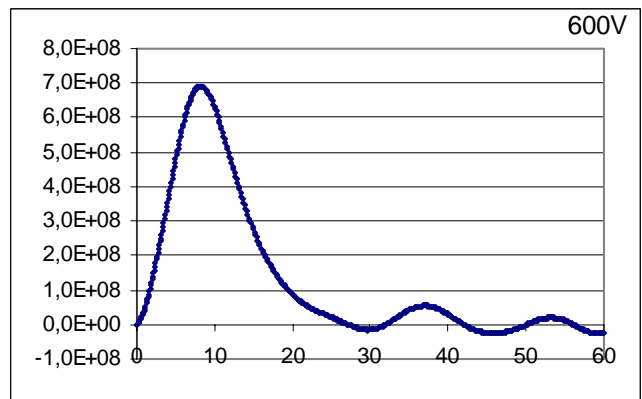
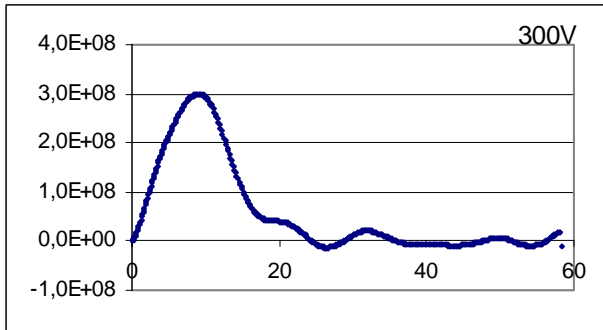
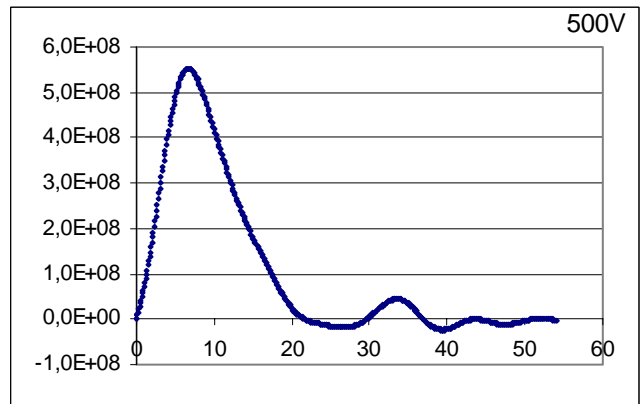
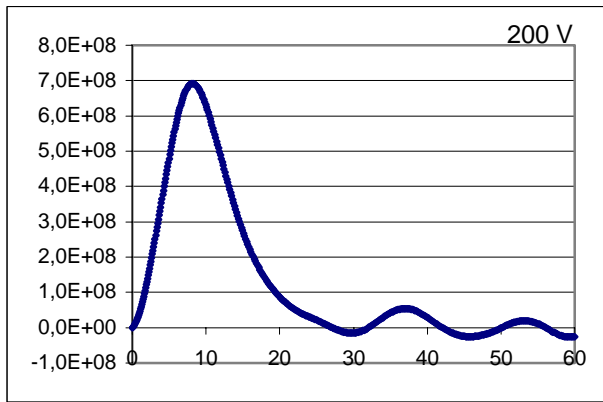

Figure 11 Probe 1, pos. II 7 mm

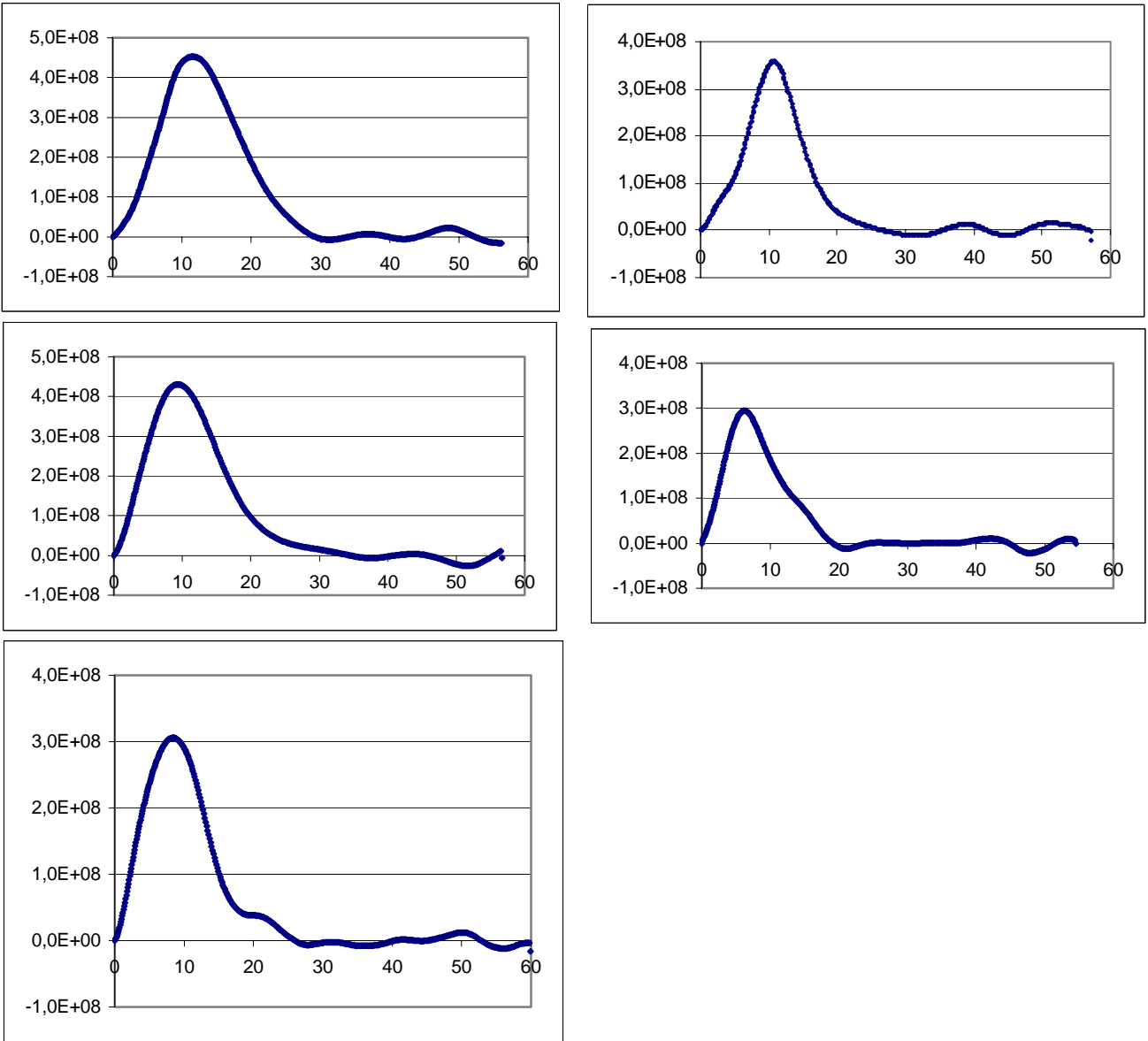

Figure 12 Probe 1, pos. I 14 mm

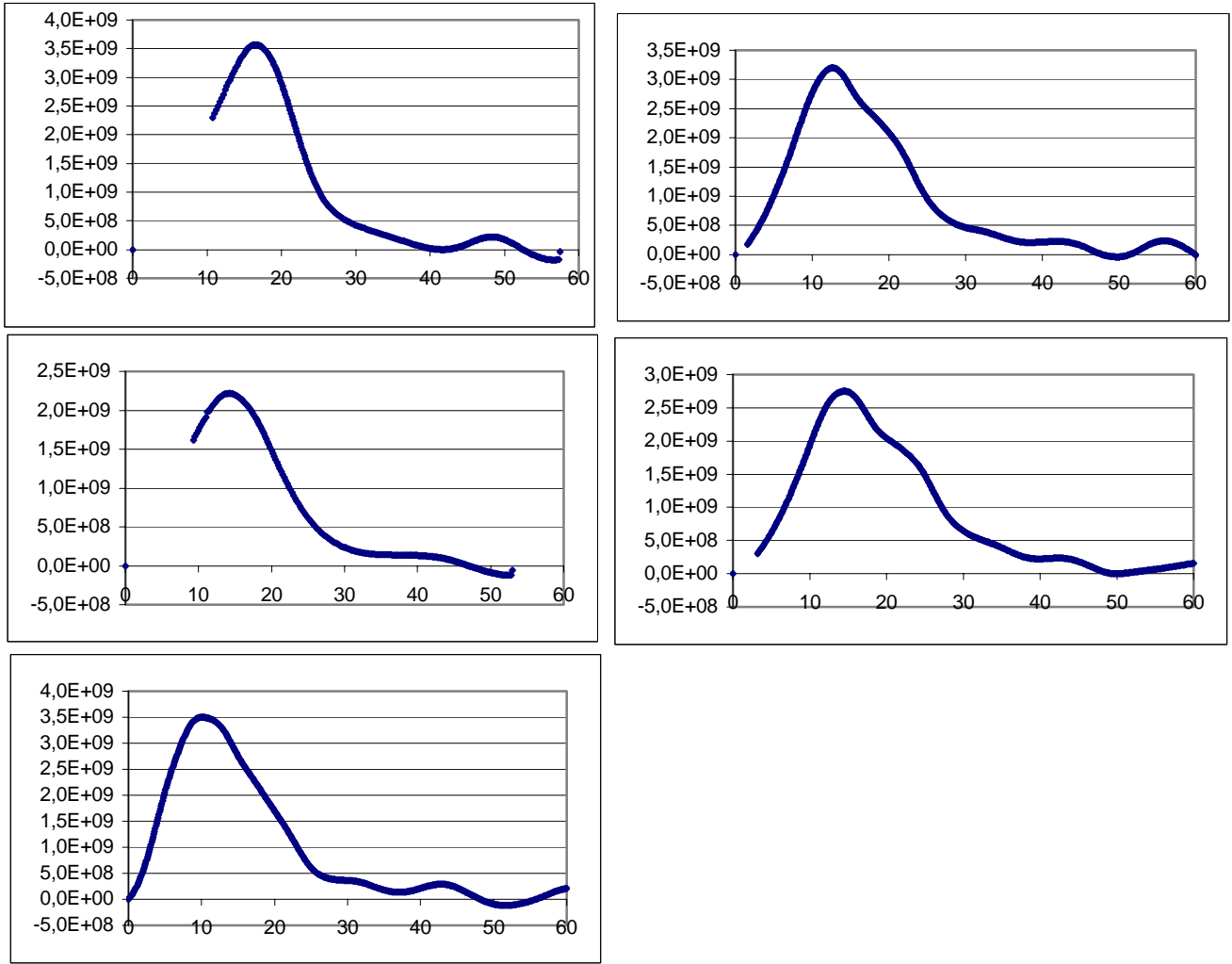

Figure 13 Probe 1, pos. I 21 mm

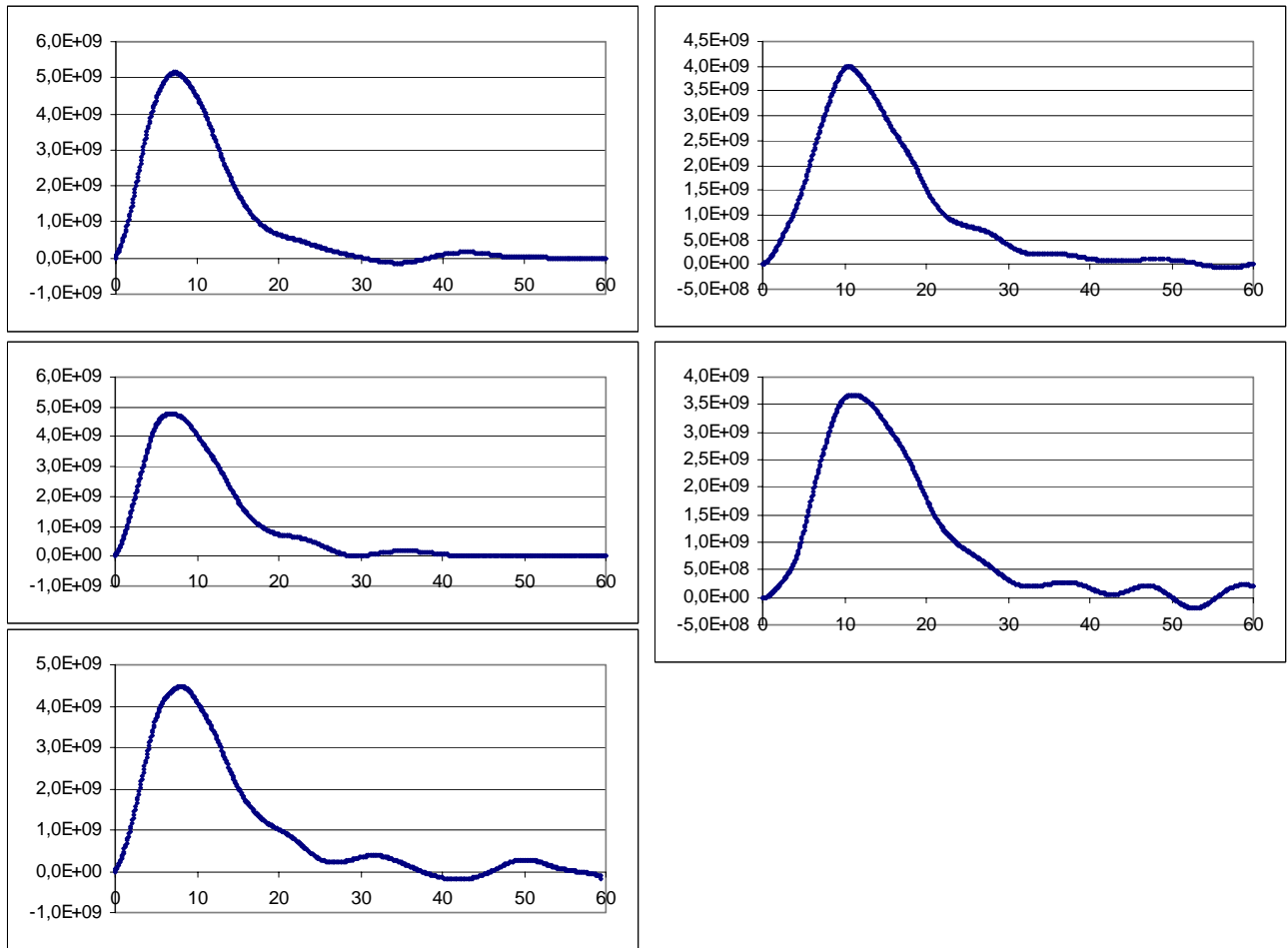

Figure 14 Probe 1, pos. I 30 mm

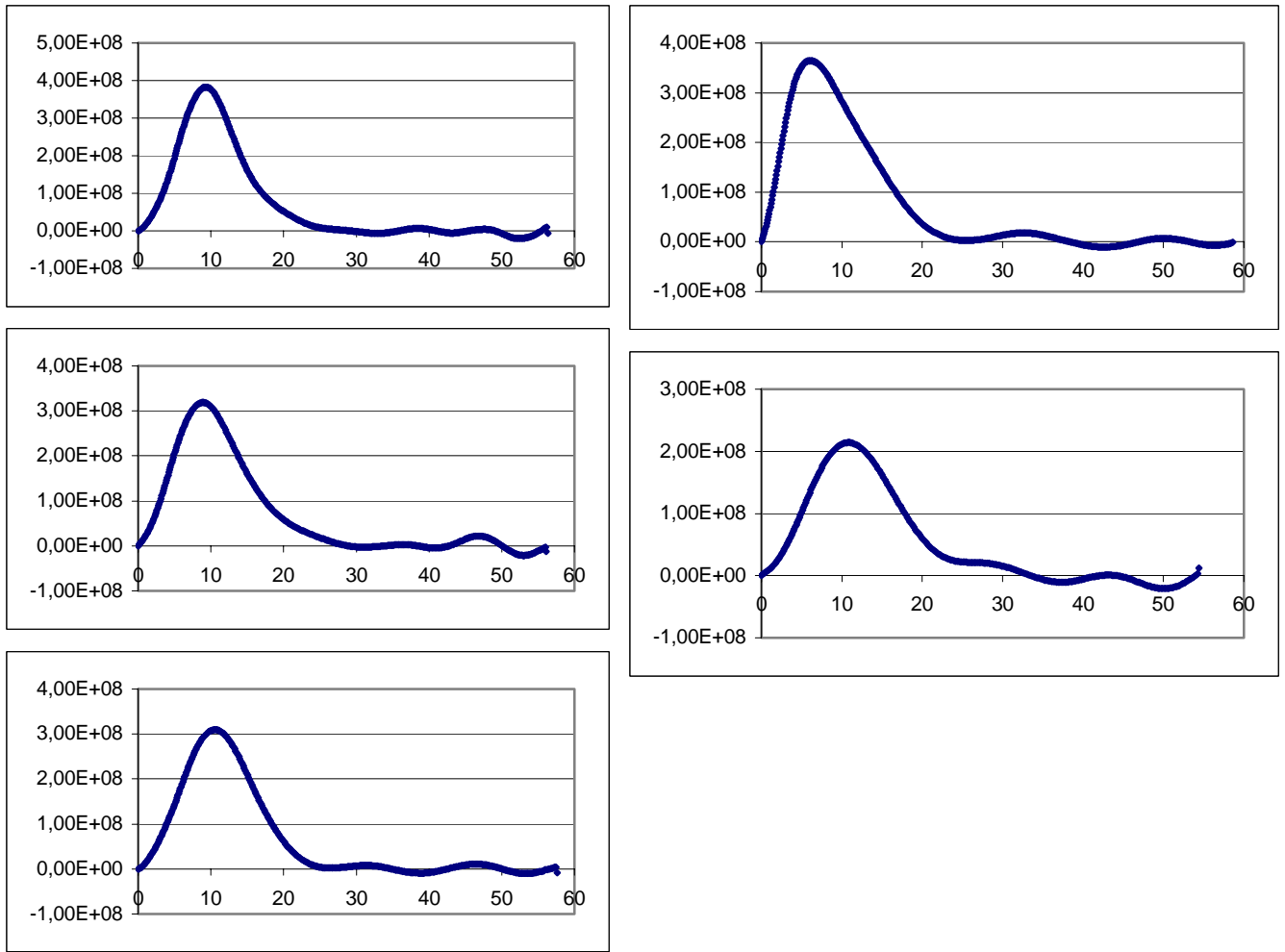

Figure 15 Probe 2, pos. I 14 mm

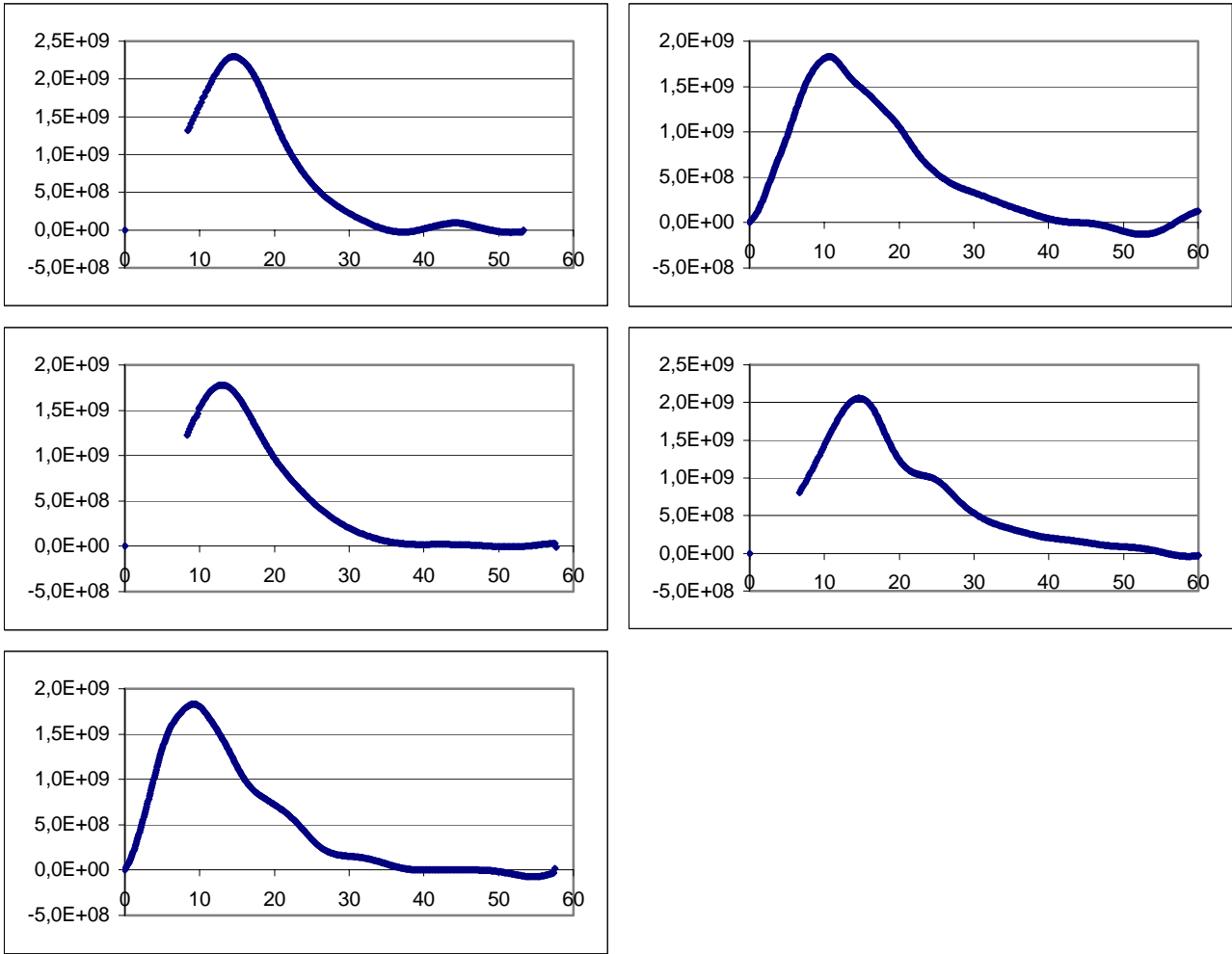

Figure 16 Probe 2, pos. I 21 mm

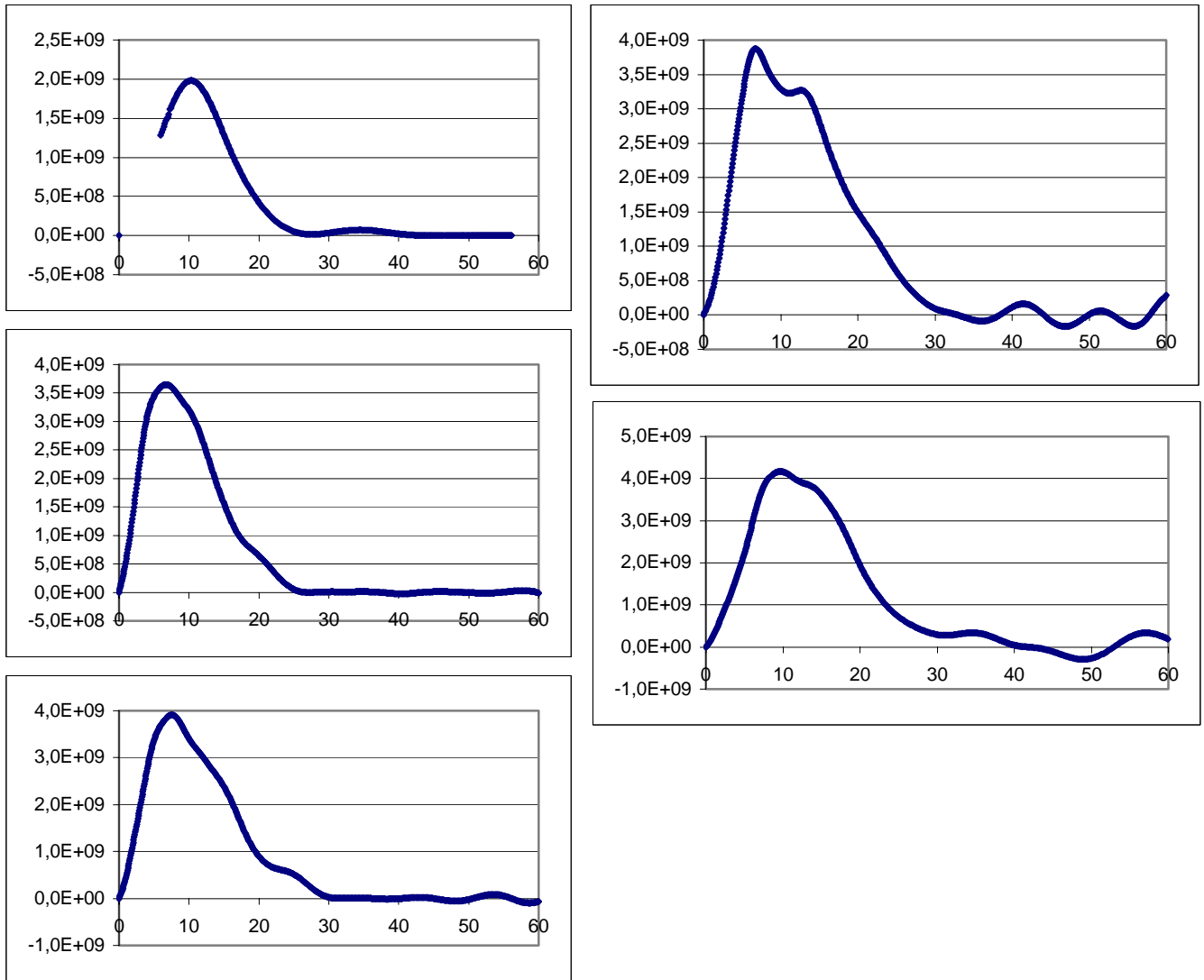

Figure 17 Probe 2, pos. I 30 mm

V. Conclusions

In conclusions it is possible to summarize that first obtained results have good agreement with results of other researchers. But there are some artifacts which maybe be connected with signal processing. So, it is necessary to modify a processing procedure.

Appendix

Table 1

	Mean value	Inaccuracy under $\Delta x_i \neq const$	Inaccuracy under $\Delta x_i = \Delta x$
$i = 0$	$X_i = x_i$ $\bar{x}_i = x_i$	$D_i^2 = \Delta x_i^2$ $\Delta \bar{x}_i = \Delta x_i$	$\Delta \bar{x}_i = \Delta x$
$0 < i < r$	$X_i = X_{i-1} - x_{2i-1} + x_{2i}$ $\bar{x}_i = X_i / (2i + 1)$	$D_i^2 = D_{i-1}^2 - (\Delta x_{2i-1})^2 + (\Delta x_{2i})^2$ $\Delta \bar{x}_i = \frac{1}{2i+1} \sqrt{D_i^2}$	$\Delta \bar{x}_i = \frac{\Delta x}{\sqrt{2i+1}}$
$r \leq i < n-r$	$X_i = X_{i-1} - x_{i-r-1} + x_{i+r}$ $\bar{x}_i = X_i / (2r + 1)$	$D_i^2 = D_{i-1}^2 - (\Delta x_{i-r-1})^2 + (\Delta x_{i+r})^2$ $\Delta \bar{x}_i = \frac{1}{2r+1} \sqrt{D_i^2}$	$\Delta \bar{x}_i = \frac{\Delta x}{\sqrt{2r+1}}$
$n - r \leq i$	$X_i = X_{i-1} - x_{2i-n-1} + x_{2i-n}$ $\bar{x}_i = X_i / [2(n-i) - 1]$	$D_i^2 = D_{i-1}^2 - (\Delta x_{2i-n-1})^2 + (\Delta x_{2i-n})^2$ $\Delta \bar{x}_i = \frac{1}{2(n-i)-1} \sqrt{D_i^2}$	$\Delta \bar{x}_i = \frac{\Delta x}{\sqrt{2(n-i)-1}}$

Table 2

	Inaccuracies are unknown	Dispersions
$i = 0$	$S_i^2 = x_i^2$ $\Delta \bar{x}_i = 0$	$\sigma_i^2 = 0$
$1 < i < r$	$S_i^2 = S_{i-1}^2 - x_{2i-1}^2 + x_{2i}^2$ $\Delta \bar{x}_i = t_{P,2i} \frac{1}{\sqrt{2i}} \sqrt{\frac{S_i^2}{2i+1} - \bar{x}_i^2}$	$\sigma_i^2 = S_i^2 / (2i + 1) - \bar{x}_i^2$
$r \leq i < n-r$	$S_i^2 = S_{i-1}^2 - x_{i-r-1}^2 + x_{i+r}^2$ $\Delta \bar{x}_i = t_{P,2r} \frac{1}{\sqrt{2r}} \sqrt{\frac{S_i^2}{2r+1} - \bar{x}_i^2}$	$\sigma_i^2 = S_i^2 / (2r + 1) - \bar{x}_i^2$
$n - r \leq i < n-1$	$S_i^2 = S_{i-1}^2 - x_{2i-n-1}^2 + x_{2i-n}^2$ $\Delta \bar{x}_i = \frac{t_{P,2(n-i-1)}}{\sqrt{2(n-i)-1}} \sqrt{\frac{S_i^2}{2(n-i)-1} - \bar{x}_i^2}$	$\sigma_i^2 = S_i^2 / [2(n-i) - 1] - \bar{x}_i^2$
$i = n-1$	$S_i^2 = x_i^2$ $\Delta \bar{x}_i = 0$	$\sigma_i^2 = 0$

Acknowledgments

The presented study is sponsored by INTAS 03 53 3358 project.

References

Periodicals

- ¹Bugrova A.I., Desiatkov A.V., Morozov A.I. Distribution function of the electrons in the accelerator with closed electron drift // *Plasma physics*. 1992. v.18. N8. pp. 963 – 975 (in Russian)
- ³Guerrini G., Michaut C., Bacal M. et al. An intense Hall-type ion source for satellite propulsion // *Rev. Sci. Instrum.* 1998. Vol.69. No 2. P.804–806.
- ⁴Fedotov V.Yu., Ivanov A.A., Guerrini G. et al. On the electron distribution function in a Hall-type thruster // *Physics of Plasmas*. 1999. Vol.6, P.4360.
- ⁶Bacal M, Pereslavtsev A.A., Tanguy M, and Vodopyanov A.V. Electron density and energy distribution function in the plume of a Hall-type thruster // *Rev. Sci. Instrum.* 1998. Vol.73. No 2. P.804–806.
- ⁹Druyvesteyn M.J., *Zs. Phys.*, 64, 790, 6 (1930).
- ¹⁰Druyvesteyn M.J., Warmoltz N., *Phyl. Mag.*, 17, 1 (1935).
- ¹²Langmuir L, Tonks L., *Phys. Rev.*, 34, 876 (1929); 33, 1070 (1929).
- ¹⁴Strickfaden W.B., Geiler K.L. Probe Measurements of the Discharge in an Operating Electron Bombardment Engine, *AIAA Journal*, V 1, № 8, 1815-1822, august 1963.
- ¹⁶Schonhuber M.J., *Zs. Angew. Phys.*, 15, 454 (1963).
- ¹⁷Schneider W.H., *Acta Phys. Austriaca*, 10, 54 (1956).
- ¹⁸Medicus G., Diffusion and Elastic Collision Losses of the "Fast Electrons" in Plasmas, *Journal of Applied Physics*, том 29, № 6, 903-908, June 1958.
- ¹⁹Medicus G., Simple Way to Obtain the Velocity Distribution of the Electrons in Gas Discharge Plasmas from Probe Curves, *Journal of Applied Physics*, том 27, № 10, 1242-1248, October 1956.

Reports, Theses, and Individual Papers

- ²Gilles Guerrini. Etude expérimentale des phénomènes de décharge et propagation d'ondes dans les propulseurs ioniques à dérive d'électrons en cycle fermé. – Thèse de Doctorat de l'Université de Province, P.M.I. N° 3450, 1997.
- ⁸INTAS #96-2276 « Physical study of small Hall thrusters used for satellite orbite control ». Intermediat report. CNES, 14 /12 /98, Ref. DTS/AE/MTE/3P NT-98-259.

Books

- ¹¹Methods of plasma investigation / Translation from english under edition of Lukianov S.U. – M. : Mir, 1971 (in Russian).
- ¹³Plasma diagnostic / Translation from english under edition of Lukianov S.U. – M. : Mir, 1967 (in Russian).
- ¹⁵Koslov O.V. Electrical probe in plasma, M.: Atomizdat, 1969, (in Russian).
- ²¹Leukov A.V. Heat-conductivity theory M., 1952 (in Russian).

Proceedings

- ⁷Pereslavtsev A.A. Electrons density and distribution function in SPT plasma jet // Paper thesis of 9-th International scientific conference for postgraduates and students, Moscow Energetic Institute, Moscow 4-5 March 2003, pp. 76 –77 (in Russian)

Electronic Publications

- ⁵Albarède A., Lago V., Lasgorceix P. et al. Interaction of a hollow cathode stream with a Hall thruster // 28th International Electric Propulsion Conference, Toulouse, Paper No. IEPC 03-333, 2003.
- ²⁰Albarede L., Vial V., Lazurenko A., Bouchoule A., Dudeck M. Hollow cathode stationary and dynamical behavior: in diode regime and with a hall thruster. Proc. '4th Int. Spacecraft Propulsion Conference', Cagliari, Sardinia, Italy 2-4 June 2004 (ESA SP-555, October 2004).